

# DPA01, PPA01



## True RMS 3-Phase voltage monitoring relay



### Benefits

- **Wide voltage range.** Working in systems from 208 to 690 VAC.
- **Output and status LED indication.** For quick troubleshooting.
- **Regenerated voltage detection.** To detect phase loss even while the motor is running.
- **Two mounting versions.** Available for DIN-rail (DPA01) and Plug-in (PPA01) mounting.

### Description

DPA01 and PPA01 are 3-phase mains monitoring relays.

They operate on 3P systems, monitoring phase loss and phase sequence.

Power supply provided by the monitored mains.

### Main features

- Monitoring 3-phase mains with 3 wires (3P).
- Detection of the correct phase sequence and phase loss.
- Changeover relay output.

### Order code

Mounting	Power supply	Component name/part number
DIN-rail	208 to 240 VAC	DPA01DM23
	208 to 480 VAC	DPA01CM44
	380 to 480 VAC	DPA01DM48
	380 to 600 VAC	DPA01CM60
	600 to 690 VAC	DPA01CM69
Plug-in	208 to 240 VAC	PPA01DM23
	208 to 415 VAC	PPA01CM44
	380 to 415 VAC	PPA01DM48

**Structure**

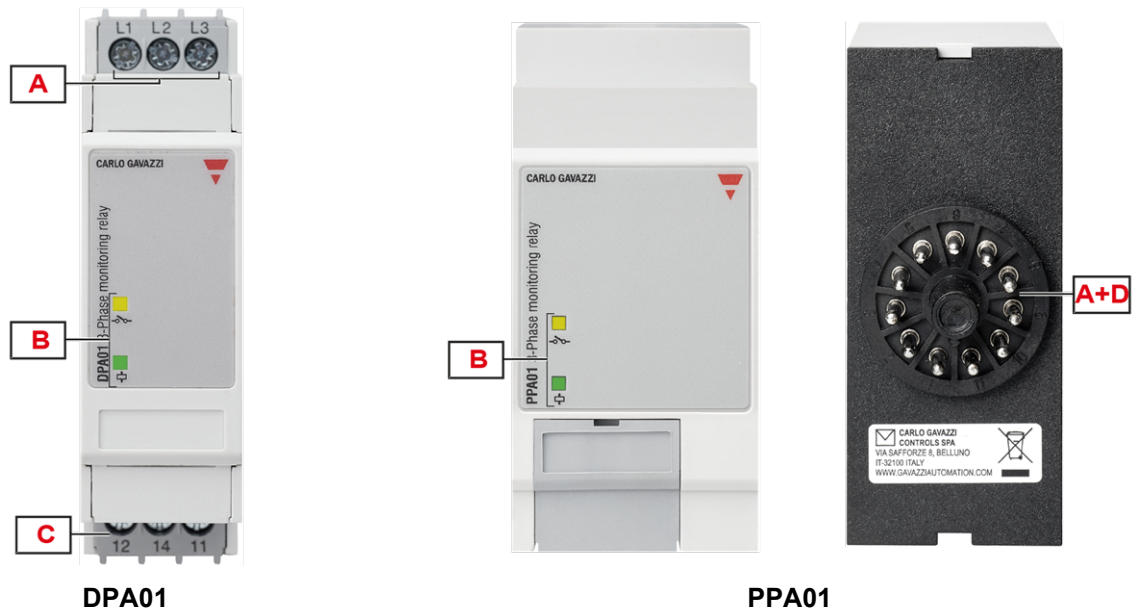

Element	Component	Function
A	Input terminals	Connection of the line voltages
B	Information LEDs	Yellow for relay output status Green for device ON
C	Output terminals	SPDT relay output (DPA01C, PPA01C) DPDT relay output (DPA01D, PPA01D)



## Features

### Power supply

<b>Power supply</b>		Supplied by measured phases (L2, L3)
<b>Overvoltage category</b>		III (IEC 60664)
<b>Voltage range</b>	<b>DPA01DM23</b> <b>PPA01DM23</b>	208 to 240 V <sub>L-L</sub> AC ± 15% (177 to 276 V)
	<b>DPA01CM44</b>	208 to 480 V <sub>L-L</sub> AC ± 15% (177 to 552 V)
	<b>PPA01CM44</b>	208 to 415 V <sub>L-L</sub> AC ± 15% (177 to 477 V)
	<b>DPA01DM48</b>	380 to 480 V <sub>L-L</sub> AC ± 15% (323 to 552 V)
	<b>PPA01DM48</b>	380 to 415 V <sub>L-L</sub> AC ± 15% (323 to 477 V)
	<b>DPA01CM60</b>	380 to 600 V <sub>L-L</sub> AC ± 15% (323 to 690 V)
	<b>DPA01CM69</b>	600 to 690 V <sub>L-L</sub> AC ± 15% (510 to 793 V)
<b>Frequency range</b>		50 to 60 Hz ± 10% sinusoidal waveform
<b>Consumption</b>	<b>DPA01DM23</b> <b>PPA01DM23</b>	< 6 VA
	<b>DPA01CM44</b> <b>PPA01CM44</b>	< 13 VA
	<b>DPA01DM48</b> <b>PPA01DM48</b>	< 10 VA
	<b>DPA01CM60</b> <b>DPA01CM69</b>	< 15 VA

### Inputs

<b>Terminals</b>		<b>DPA01:</b> L1, L2, L3 <b>PPA01:</b> 5, 6, 7
<b>Measured variables</b>		Phase sequence Phase loss 3P: voltages V <sub>L12</sub> , V <sub>L23</sub> , V <sub>L31</sub>
<b>Nominal line range</b>	<b>DPA01DM23</b> <b>PPA01DM23</b>	208 to 240 VAC ± 15% (177 to 276 VAC)
	<b>DPA01CM44</b>	208 to 480 VAC ± 15% (177 to 552 VAC)
	<b>PPA01CM44</b>	208 to 415 VAC ± 15% (177 to 477 VAC)
	<b>DPA01DM48</b>	380 to 480 VAC ± 15% (323 to 552 VAC)
	<b>PPA01DM48</b>	380 to 415 VAC ± 15% (323 to 477 VAC)
	<b>DPA01CM60</b>	380 to 600 VAC ± 15% (323 to 690 VAC)
	<b>DPA01CM69</b>	600 to 690 VAC ± 15% (510 to 793 VAC)

## Outputs

Terminals	DPA01C DPA01D	11, 12, 14 11, 12, 14, 21, 22, 24
	PPA01C PPA01D	1, 3, 4 1, 3, 4, 8, 9, 10
Number of outputs	DPA01C PPA01C	1
	DPA01D PPA01D	2
Type	DPA01C PPA01C	SPDT electromechanical relay with changeover contacts
	DPA01D PPA01D	DPDT electromechanical relay with changeover contacts
Logic		Output de-energised on alarm
Contact rating	DPA01C PPA01C	<b>I<sub>th</sub></b> : 8 A @ 250 VAC <b>DC12</b> : 5 A @ 24 VDC <b>AC15</b> : 2.5 A @ 250 VAC <b>DC13</b> : 2.5 A @ 24 VDC
	DPA01D PPA01D	<b>I<sub>th</sub></b> : 8 A @ 250 VAC <b>AC15</b> : 3 A @ 250 VAC <b>DC13</b> : 2 A @ 24 VDC
Electrical lifetime		≥50 x 10 <sup>3</sup> operations (at 8 A, 250 V, cos φ= 1)
Mechanical lifetime		>30 x 10 <sup>6</sup> operations
Assignment		Associated to all alarm types

## Insulation

Terminals		Basic insulation
Inputs: L1, L2, L3 (DPA) / 5, 6, 7 (PPA) to output: 11, 12, 14 (DPA) / 1, 3, 4 (PPA)	DPA01C PPA01C	2.5 kVrms, 4 kV impulse 1.2/50 μs
Inputs: L1, L2, L3 (DPA) / 5, 6, 7 (PPA) to outputs: 11, 12, 14, 21, 22, 24 (DPA) / 1, 3, 4, 8, 9, 10 (PPA)	DPA01D PPA01D	

## General

<b>Material</b>	Polyamide (Nylon) (PA66/6) or Phenylene ether + Polystyrene (PPE-PS)
	Flammability rating: HB according to UL 94
<b>Colour</b>	RAL7035 (light grey)
<b>Dimensions (W x H x D)</b>	DPA01: 22.5 x 80 x 99.5 mm (0.89 x 3.15 x 3.92 in) PPA01: 36 x 80 x 94 mm (1.42 x 3.15 x 3.7 in)
<b>Weight</b>	Approx. 100 g (3.53 oz)
<b>Terminals</b>	Cable size from 0.05 to 2.5 mm <sup>2</sup> (AWG30 to AWG13), stranded or solid
<b>Tightening torque</b>	Max. 0.5 Nm (4.425 lbin)
<b>Terminal type</b>	Double cage screw terminals (DPA01), Undecal Plug-in terminals (PPA01)

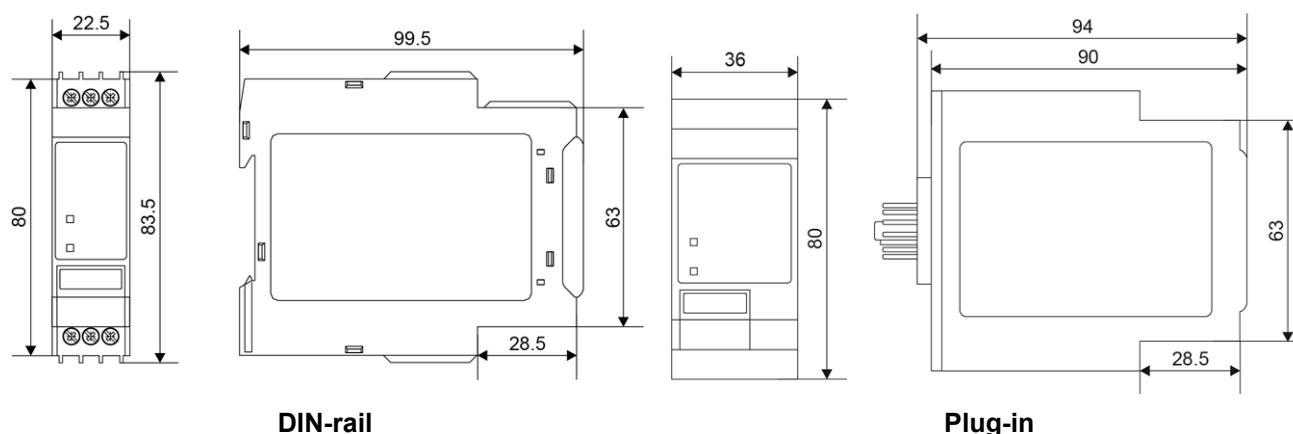

DIN-rail

Plug-in

## Environmental

<b>Operating temperature</b>	50 Hz: -20 to 60 °C (-4 to 140 °F)
	60 Hz: -20 to 50 °C (-4 to 122 °F)
<b>Storage temperature</b>	-30 to 80 °C (-22 to 176 °F)
<b>Relative humidity</b>	5 - 95% non condensing
<b>Protection degree</b>	IP20
<b>Pollution degree</b>	2
<b>Operating max altitude</b>	2000 m amsl (6560 ft)
<b>Salinity</b>	Non saline environment
<b>UV resistance</b>	No















### Vibration/Shock resistance

Test condition	Test	Level
Tests with unpacked device	Vibration response (IEC60255-21-1)	Class 1
	Vibration endurance (IEC 60255-21-1)	Class 1
	Shock (IEC 60255-21-2)	Class 1
	Bump (IEC 60255-21-2)	Class 1
Tests with packed device	Vibration random (IEC60068-2-64)	Class 1
	Shock (IEC 60255-21-2)	Class 1
	Bump (IEC 60255-21-2)	Class 1

Class 1: monitoring devices for normal use in power plants, substations and industrial plants and for normal transportation conditions.

The packaging type is designed and implemented in such manner that the severity class parameters will not be exceeded during transportation.

### Compatibility and conformity

Marking	 			
Directives	2014/35/EU (LVD - Low voltage) 2014/30/EU (EMC - Electromagnetic compatibility)			
Standards	Insulation coordination: EN 60664-1 Immunity: EN61000-6-2 Emission: EN61000-6-3			
Approvals	DPA01DM23 DPA01CM44 DPA01DM48 DPA01CM60		 	
	DPA01CM69			
	PPA01CM44		 	
	PPA01DM23 PPA01DM48			

## Operating description

### Device configuration

The relay operates when all the phases are present and the phase sequence is correct.

### Alarms

- Phase loss and incorrect phase sequence cause immediate output relay de-energisation.

Phase loss alarm	
Input variables	L1-L2, L2-L3 and L3-L1
Alarm setpoint	One phase $\leq$ 85% of the rated value (regenerated voltage detection)
Restore setpoint	All phases $>$ 85% of the rated value + Hysteresis
Hysteresis	2% fixed
Delay ON	$<$ 100 ms
Delay OFF	$<$ 350 ms

Phase sequence alarm	
Input variables	Connection L1, L2, L3
Delay ON	$<$ 100 ms
Delay OFF	$<$ 350 ms

### Information LEDs

Colour	Status		Description
Green ( $\text{⬢}$ )	Power supply	ON	Power supply ON
		OFF	Power supply OFF
Yellow ( $\text{⬢}$ )	Relay output	ON	Energised
		OFF	De-energised

## Operating diagram

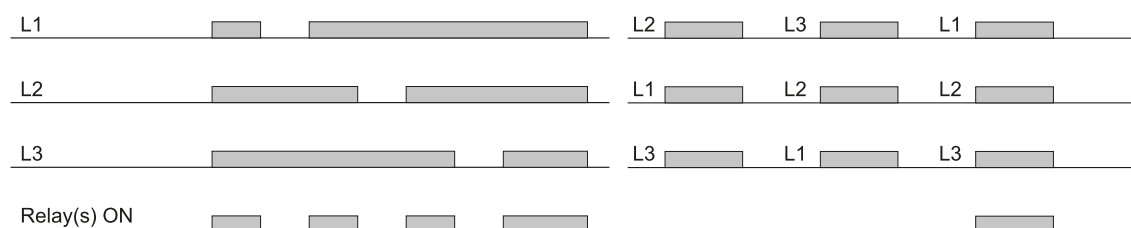

Total phase loss, phase sequence

## Connection diagrams

(\*) NOTE: fuses F of 315 mA delayed, if required by local law.

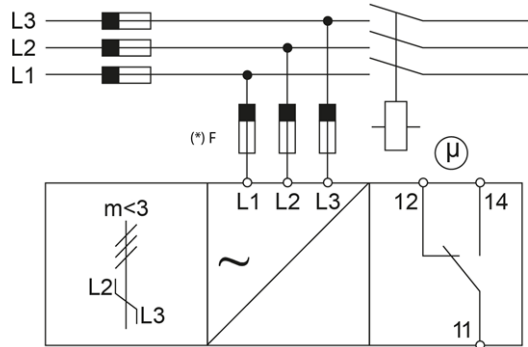

DPA01C

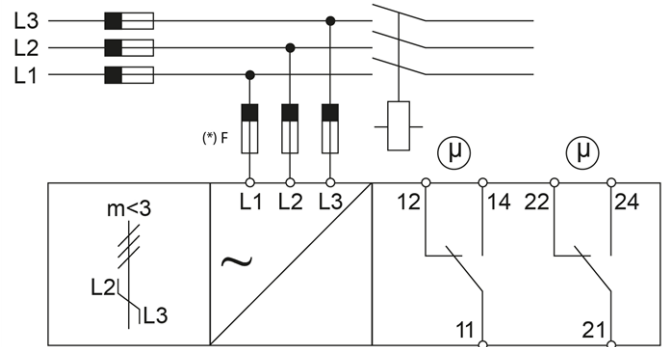

DPA01D

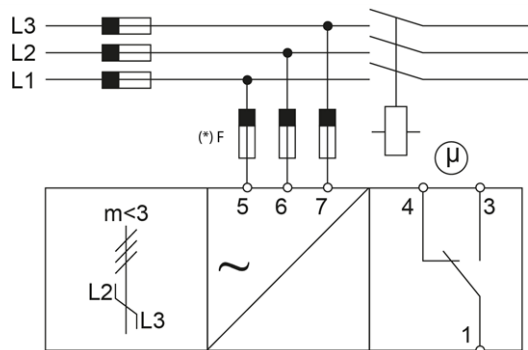

PPA01C

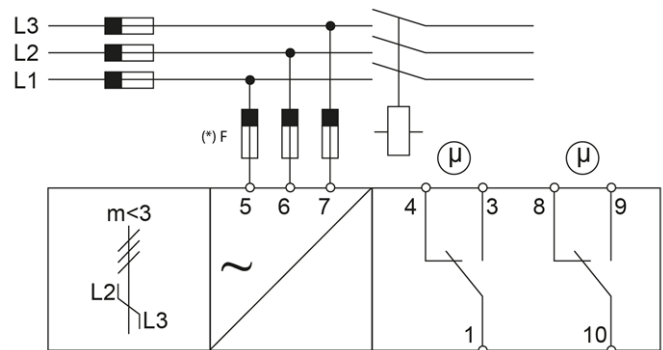



PPA01D



## References

### Further reading

Information	Where to find it	QR code
Installation manual	<a href="https://carlogavazzi-pss.com/manuals/DPA_PPA_IM_html">https://carlogavazzi-pss.com/manuals/DPA_PPA_IM_html</a>	
PSS selection tool	<a href="https://carlogavazzi-pss.com/">https://carlogavazzi-pss.com/</a>	



COPYRIGHT ©2023

Content subject to change. Download the PDF: [www.gavazziautomation.com](http://www.gavazziautomation.com)